

Fluid Cooling Industrial AOF Series

Performance Notes

- AO with removable filter
- Adjustable louvers (manual)
- Medium flow rates
- Moderate heat removal
- One or two pass option



OPTIONS
 Internal SAE straight threads
 SAE & metric connections
 Internal pressure bypass
 Corrosive resistant marine coating

Ratings

Maximum Operating Pressure
 300 PSI

Test Pressure
 300 PSI

Maximum Operating Temperature
 400°F

Materials

Tubes Copper

Fins Aluminum

Turbulators Steel

Fan Blade Aluminum with steel hub

Fan Guard Zinc plated steel

Cabinet Steel with powder coat finish

Manifolds Steel

Connections Steel

Net Weight (LBS)

Model	Weight
AOF-5	60
AOF-10	70
AOF-15	80
AOF-20	95
AOF-25	125
AOF-30	140
AOF-35	165
AOF-40	230

Piping Diagram

One Pass with Bypass

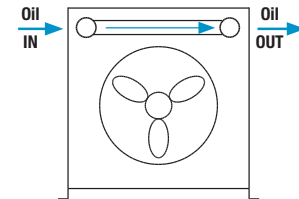

Two Pass with Bypass

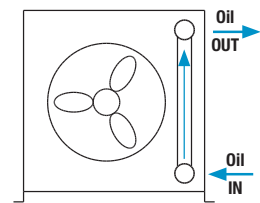

Replacement Air Filters

Model	Fiberglass Disposable Type Part Number	Aluminum Washable Type Part Number
AOF - 5	65528	65559
AOF - 10	65530	65560
AOF - 15	65507	65561
AOF - 20	65532	65562
AOF - 25	65519	65563
AOF - 30	65535	65564
AOF - 35	65537	65565
AOF - 40	65543	65566

How to Order

	-		-		-		-		-		-	
Model Series		Model Size Selected		Number of Passes*		Connection Type		Bypass Setting*		Foot Mounted Brackets		Specify Motor Required
AOF - No Relief Valve AOFR - Internal pressure bypass included				Blank - No Bypass 1 - One Pass 2 - Two Pass		Blank - NPT S - SAE M - Metric		Blank - No Bypass 30-30 - 30 PSI 60 - 60 PSI		Blank - No Brackets FB - Foot Brackets		Single Phase Single Phase Expl. Proof Three Phase Three Phase 575 Volt Three Phase Expl. Proof

*ADD FOR AOFR MODELS: Bypass setting & number of passes.
 This is a partial flow pressure bypass only. It is not designed to be a full flow system bypass.

Dimensions

Model	A	B	C	D	E	F	G	H	J	K	L	M		N	P	Q	R	S	T
												NPT Male	SAE Female						
AOF-5	7.40	14.81	5.90	11.81	17.50	9.19	8.31	6.47	12.94	3.78	7.69	1"	#16 SAE	5.84	11.69	10.06	1.09	3.92	—
AOF-10	9.50	19.00	6.56	13.12	17.00	10.50	12.50	8.56	17.12	4.44	8.88	1"	1 1/16-12UN-2B Thread	7.94	15.88	14.38	1.09	3.92	—
AOF-15	10.19	20.38	7.87	15.75	17.62	13.12	13.88	9.25	18.50	5.75	11.50	1"		8.62	17.25	15.62	1.09	3.92	—
AOF-20	11.91	23.81	9.19	18.38	19.62	15.75	17.91	10.90	21.81	7.00	14.00	1 1/4"		10.28	20.56	18.62	1.09	3.92	—
AOF-25	13.34	26.68	11.81	23.62	20.68	21.00	20.19	12.40	24.81	9.62	19.25	1 1/4"		11.78	23.56	21.62	1.09	3.92	—
AOF-30	15.81	31.62	13.78	27.56	20.12	24.94	25.12	14.87	29.75	11.59	23.19	1 1/4"	1 1/8-12UN-2B Thread	14.25	28.50	26.62	1.09	3.92	11.00
AOF-35	16.90	33.81	15.09	30.19	21.25	27.56	27.31	15.97	31.94	12.90	25.81	1 1/4"		15.34	30.69	28.88	1.09	3.94	11.00
AOF-40	20.18	41.62	18.37	36.75	20.31	34.12	35.12	19.87	39.75	16.19	32.38	1 1/4"		19.25	38.50	37.00	1.18	3.87	13.25

NOTE: All dimensions in inches.

Piping Diagram Without Bypass

One Pass

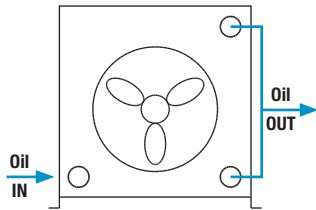

Two Pass

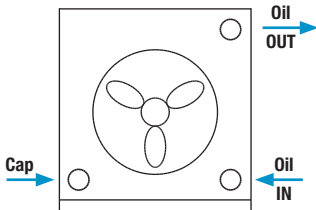

*See dimension chart for NPT or optional internal SAE connection size.

Fan Rotation Clockwise/Facing Motor Shaft

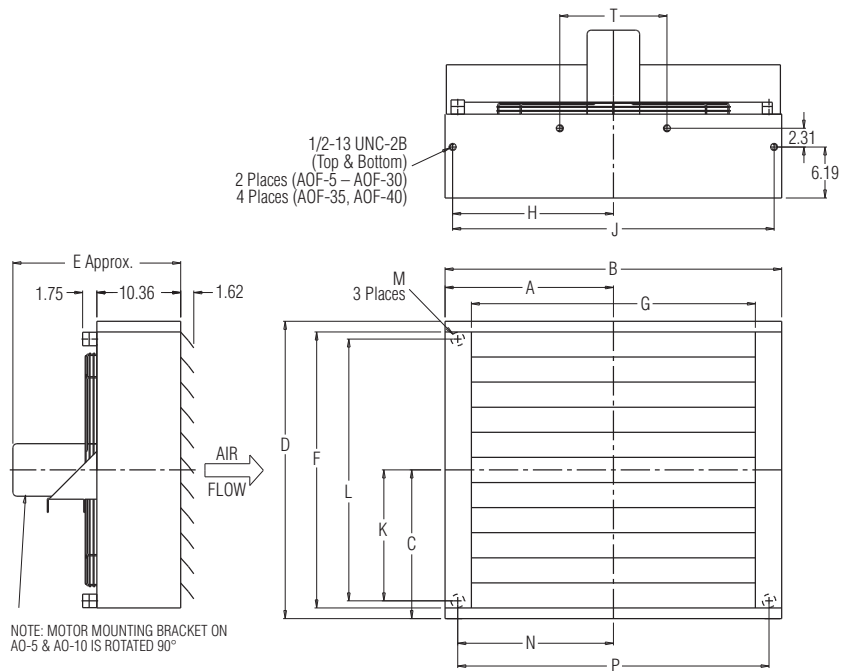

NOTE: MOTOR MOUNTING BRACKET ON AO-5 & AO-10 IS ROTATED 90°

Lubrication Notes

Caution: Do not over oil or over grease. **Ball bearings** – No grease needed at start up. Grease as follows:

5,000 Hours/Year	5 Year Grease Interval
Continuous — Normal Applications	2 Years
Seasonal Service — Motor is idle for 6 months or more	1 Year
Continuous — High ambients, dirty or moist locations, high vibration	6 Months

Performance Curves

One Pass Oil

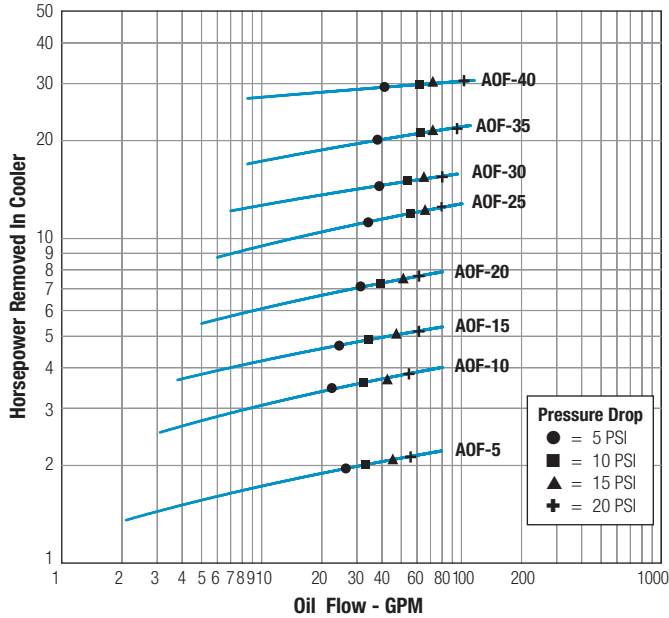

Two Pass Oil

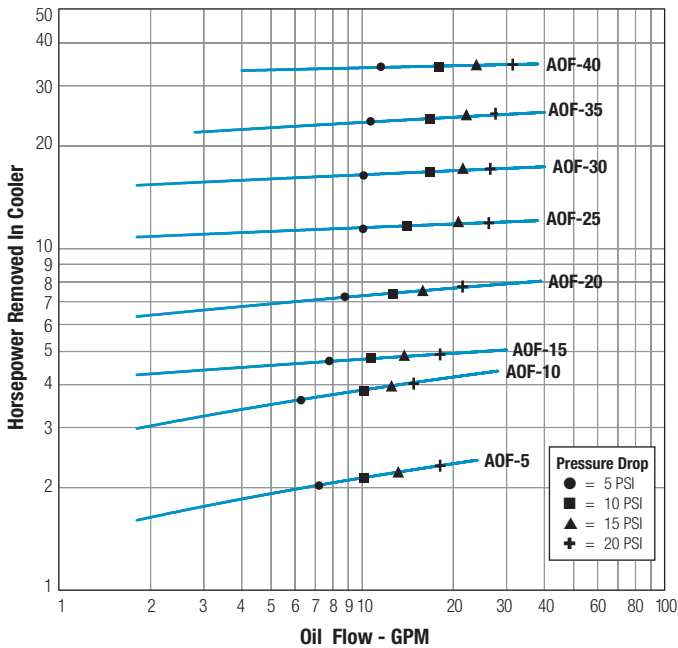

Oil Pressure Correction

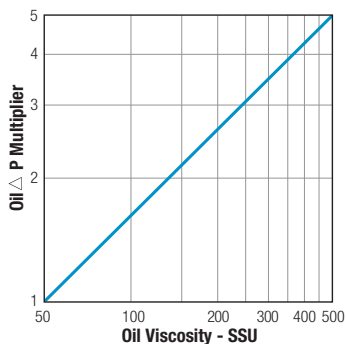

Selection Procedure

Performance Curves are based on 50SSU oil leaving the cooler 40°F higher than the ambient air temperature used for cooling. This is also referred to as a 40°F approach temperature.

STEP 1 Determine the Heat Load. This will vary with different systems, but typically coolers are sized to remove 25 to 50% of the input nameplate horsepower.
 (Example: 100 HP Power Unit x .33 = 33 HP Heat load.)
 If BTU/HR is known: $HP = \frac{BTU/HR}{2545}$

STEP 2 Determine Approach Temperature. Desired oil leaving cooler °F – Ambient air temp. °F = Actual Approach

STEP 3 Determine Curve Horsepower Heat Load. Enter the information from above:
 Horsepower heat load x $\frac{40 \times Cv}{Actual\ Approach} = Curve\ Horsepower$

STEP 4 Enter curves at oil flow through cooler and curve horsepower. Any curve above the intersecting point will work.

STEP 5 Determine Oil Pressure Drop from Curves:
 ● = 5 PSI ■ = 10 PSI ▲ = 15 PSI + = 20 PSI
 Multiply pressure drop from curve by correction factor found in oil ΔP correction curve.

Desired Reservoir Temperature

Return Line Cooling: Desired temperature is the oil temperature leaving the cooler. This will be the same temperature that will be found in the reservoir.

Off-Line Recirculation Cooling Loop: Desired temperature is the oil temperature entering the cooler. In this case, the oil temperature change must be determined so that the actual oil leaving temperature can be found. Calculate the oil temperature change (oil Δ T) with this formula:
 $Oil\ \Delta\ T = (BTU's/HR) / (GPM\ Oil\ Flow \times 210)$

To calculate the oil leaving temperature from the cooler, use this formula:
 $Oil\ Leaving\ Temp. = Oil\ Entering\ Temp - Oil\ \Delta\ T$

This formula may also be used in any application where the only temperature available is the entering oil temperature.

Oil Pressure Drop: Most systems can tolerate a pressure drop through the heat exchanger of 20 to 30 PSI. Excessive pressure drop should be avoided. Care should be taken to limit pressure drop to 5 PSI or less for case drain applications where high back pressure may damage the pump shaft seals.

Oil Temperature

Typical operating temperature ranges are:

Hydraulic Motor Oil	110° - 130°F
Hydrostatic Drive Oil	130° - 180°F
Bearing Lube Oil	120° - 160°F
Lube Oil Circuits	110° - 130°F

Specifications

Electric motor & Fan data*

Model	CFM	Sound dB(A)* at 7 FT	HP	Volts	Phase	Full Load Amps	HZ	Nema Frame	RPM	Type	Circuit	Thermal Overload	Bearing B-Ball
AOF-5	465	68	1/6	115/208-230	1	4./2.1-2	60	48	1725	TEFC	C	No	B
	494	70	1/4	208-230/460	3	1.4-1.3/.65	60	48	1725	TEFC	D	No	B
AOF-10	669	68	1/6	115/208-230	1	4./2.1-2	60	48	1725	TEFC	C	No	B
	710	70	1/4	208-230/460	3	1.4-1.3/.65	60	48	1725	TEFC	D	No	B
AOF-15	956	69	1/4	115/208-230	1	5.8/3-2.9	60	48	1725	TEFC	C	No	B
	1015	71	1/4	208-230/460	3	1.4-1.3/.65	60	48	1725	TEFC	D	No	B
AOF-20	1460	70	1/2	115/208-230	1	7.8/4.1-3.9	60	48	1725	TEFC	C	No	B
	1555	72	1/2	208-230/460	3	2.1-2./1.	60	48	1725	TEFC	D	No	B
AOF-25	2160	72	1/2	115/208-230	1	8/4.2-4	60	56	1140	TEFC	C	No	B
	2240	73	1/2	208-230/460	3	2.5-2.4/1.2	60	56	1140	TEFC	D	No	B
AOF-30	2990	75	1/2	115/208-230	1	8/4.2-4	60	56	1140	TEFC	C	No	B
	3100	76	1/2	208-230/460	3	2.5-2.4/1.2	60	56	1140	TEFC	D	No	B
AOF-35	Not Available				1	4-3.8/1.9	60	56	1140	TEFC	D	No	B
	4370	77	1	208-230/460	3	4-3.8/1.9	60	56	1140	TEFC	D	No	B
AOF-40	Not Available				1	4-3.8/1.9	60	56	1140	TEFC	D	No	B
	5450	79	1	208-230/460	3	4-3.8/1.9	60	56	1140	TEFC	D	No	B

*Published electrical ratings are approximate, and may vary because of motor brand. Actual ratings are on motor nameplate.

**Catalog dB(A) sound levels are at seven (7) feet. dB(A) sound levels increase by six (6) dB(A) for halving this distance and decrease by six (6) dB(A) for doubling this distance.

Explosion Proof Motors (Class I GP.D & Class II GP.F, G)*

Model	CFM	Sound dB(A)* at 7 FT	HP	Volts	Phase	Full Load Amps	HZ	Nema Frame	RPM	Type	Circuit	Thermal Overload	Bearing B-Ball
AOF-5	494	68	1/4	115/230	1	5.8/2.9	60	48	1725	FC	C	Yes	B
	494	70	1/4	208-230/460	3	1.4-1.3/.65	60	48	1725	FC	D	Yes	B
AOF-10	710	68	1/4	115/230	1	5.8/2.9	60	48	1725	FC	C	Yes	B
	710	70	1/4	208-230/460	3	1.4-1.3/.65	60	48	1725	FC	D	Yes	B
AOF-15	1015	69	1/4	115/230	1	5.8/2.9	60	48	1725	FC	C	Yes	B
	1015	71	1/4	208-230/460	3	1.4-1.3/.65	60	48	1725	FC	D	Yes	B
AOF-20	1555	70	1/2	115/230	1	7.8/3.9	60	48	1725	FC	C	Yes	B
	1555	72	1/2	208-230/460	3	2.1-2./1.	60	48	1725	FC	D	Yes	B
AOF-25	2240	72	1/2	115/230	1	8./4.	60	56	1140	FC	C	Yes	B
	2240	73	1/2	230/460	3	2.5-2.4/1.2	60	56	1140	FC	D	Yes	B
AOF-30	3100	75	1/2	115/230	1	8./4.	60	56	1140	FC	C	Yes	B
	3100	76	1/2	230/460	3	2.5-2.4/1.2	60	56	1140	FC	D	Yes	B
AOF-35 ▲	Not Available				1	3.8/1.9	60	56	1140	FC	D	No	B
	4370	77	1	230/460	3	3.8/1.9	60	56	1140	FC	D	No	B
AOF-40 ▲	Not Available				1	3.8/1.9	60	56	1140	FC	D	No	B
	5450	79	1	230/460	3	3.8/1.9	60	56	1140	FC	D	No	B

▲ = AOF 35 & 40, CL. 1, GP. D only **TEFC** = Totally enclosed, fan cooled **FC** = Fan cooled **C** = Capacitor start - Induction run **D** = Squirrel cage

*Published electrical ratings are approximate, and may vary because of motor brand. Actual ratings are on motor nameplate.

575 Volt Specifications

Model	CFM	Sound dB(A)** at 7 FT	HP	Volts	Phase	Full Load Amps	HZ	Nema Frame	RPM	Type	Circuit	Thermal Overload	Bearing B-Ball
AOF-5	494	70	1/4	575	3	.52	60	48	1725	TEFC	D	No	B
AOF-10	710	70	1/4	575	3	.52	60	48	1725	TEFC	D	No	B
AOF-15	1015	71	1/4	575	3	.52	60	48	1725	TEFC	D	No	B
AOF-20	1555	72	1/4	575	3	.80	60	48	1725	TEFC	D	No	B
AOF-25	2240	73	1/2	575	3	.88	60	56	1140	TEFC	D	No	B
AOF-30	3100	76	1/2	575	3	.88	60	56	1140	TEFC	D	No	B
AOF-35	4370	77	1	575	3	1.6	60	56	1140	TEFC	D	No	B
AOF-40	5450	79	1	575	3	1.6	60	56	1140	TEFC	D	No	B

*Catalog dB (A) sound levels at seven (7) feet. dB (A) sound levels increase by six (6) dB (A) for halving this distance, and decrease by six (6) dB (A) for doubling this distance.

C_v Viscosity Correction

Average Oil Temp °F	OIL					
	SAE 5 110 SSU at 100°F 40 SSU at 210°F	SAE 10 150 SSU at 100°F 43 SSU at 210°F	SAE 20 275 SSU at 100°F 50 SSU at 210°F	SAE 30 500 SSU at 100°F 65 SSU at 210°F	SAE 40 750 SSU at 100°F 75 SSU at 210°F	50-50 Ethylene Glycol & Water
100	1.14	1.22	1.35	1.58	1.77	1.11
150	1.01	1.05	1.11	1.21	1.31	1.02
200	.99	1.00	1.01	1.08	1.10	.96
250	.95	.98	.99	1.00	1.00	.95

General Information

1. Air cooled oil coolers are built for operation with maximum oil pressures of 300 PSI and temperatures of 400°F.
2. The motors furnished are specially built for fan duty. They are guaranteed by the manufacturer for operation in a maximum ambient temperature of 104°F. Consideration should be given to installation location so motors are not subjected to temperatures above this level.
3. Air/oil coolers that are to be installed for utilization of waste heat for the space heating should be mounted 7 to 14 feet above the floor depending on the structure, for proper heat distribution.

Installation

1. "AO" and "AOF" coolers are designed for suspension by eye bolts or threaded hangar rods screwed into the upper and lower covers in 1/2"-13 threaded holes; "AOVH" coolers have 6 to 12 holes (0.56" diameter) in the base for mounting. Refer to product page for location and quantity.
2. Units should not be located in corrosive atmospheres as rapid deterioration of casing, cooling coil, fan and motor may take place resulting in reduced life.
3. For proper air flow, a minimum of 12" should be allowed between the oil cooler fan and any walls or obstructions.
4. Piping should be sized based on oil flow and pressure drop requirements and not on the oil coolers supply and return connection size. Piping should also be properly supported to prevent excessive strain to connection, manifolds, etc.
5. Filter located ahead of the cooler should be installed to trap scale, dirt or sludge that may be present in piping and equipment, or that may accumulate with use. A thermostatic or spring loaded by-pass relief valve installed ahead of the cooler may be helpful to speed warm-up and relieve the system of excessive pressure. All accessories should be considered in the original heat rejection and piping calculations.
6. Electric Motors: CAUTION To prevent possible electrical shock, it is important to make sure this unit is grounded properly. Connect motor only to a power supply of the same characteristics as shown on the motor nameplate. Voltage may vary 10% of nameplate voltage. Be sure to provide proper fusing to prevent possible motor burnout. Follow wiring diagram printed on motor nameplate or in terminal box. Before starting motor, follow motor manufacturer recommendations. Turn fan manually to eliminate possible motor burn out in the event the fan has become damaged in shipment. Observe operation carefully after motor is started for the first time.
7. Hydraulic Motors: Connect motor, port B, to inlet oil line and return line to port A for correct rotation. A filter is highly recommended upstream of the motor rated at 25 micron nominal. Controlling oil flow rate as specified on motor data sheet with cooler is very important. Maximum oil pressure to motor is 2000 PSI, minimum pressure is shown on motor data sheet. Do not allow dirty oil to enter the motor. Excessive flows will cause fan blade failure. Insufficient flows to motor will reduce cooling capacity.

Maintenance

Inspect the unit regularly for loose bolts and connections, rust and corrosion, and dirty or clogged heat transfer surfaces (cooling coil).

Heat Transfer Surface

Dirt and dust should be removed by brushing the fins and tubes and blowing loose dirt off with an air hose. Should the surface be greasy, the motor should be removed and the fins and tubes brushed or sprayed with a mild alkaline solution, or a non-flammable degreasing fluid. Follow with a hot water rinse and dry thoroughly. A steam hose may also be used effectively.

Casing, Fan and Motor: Dirt and grease should be removed from these parts. Rusty or corroded surfaces should be sanded clean and repainted.

Internal Cleaning

At least once a year piping should be disconnected and a degreasing agent or flushing oil circulated through the unit to remove sludge from turbulators and internal tube surfaces to return the unit to full capacity. A thorough cleaning of the entire system in the same manner is preferable to avoid carry-over from uncleaned piping, pump and accessories. The strainer of any filtering devices should be removed and serviced following this cleaning operation.

Electric Motor

Keep outside surface free of dirt and grease so motor will cool properly. Make sure cooling air over motor is not obstructed. Pre-lubricated ball bearing motors are normally furnished and require no grease for about 5 to 10 years. Sleeve bearing motors require oil after three years.

Hydraulic Motor

Change any oil filter(s) in the motor circuit as frequently as necessary to assure that good, clean oil is maintained.

Units with Replaceable Air Filters

Examine filters for dirt and grease accumulation twice yearly, or more if operating conditions dictate. If disposable filters are used, replace as required. If the washable aluminum filters are used, wash with a warm water and soap solution that will remove dirt and cut grease build-up. Make sure that the aluminum filter is completely dry before replacing the unit. This filter can be made more effective if treated with a lightweight oil before placing in service. It is recommended that a spare aluminum filter be kept in stock to minimize downtime during the filter cleaning operation.

Repair or Replacement of Parts

When ordering replacement parts or making inquiry regarding service, mention model number, serial number and the original purchase order number. Any reference to the motor must carry full nameplate data.

Air / Oil Heat Exchangers

One Pass

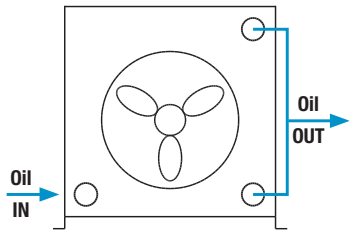

Two Pass

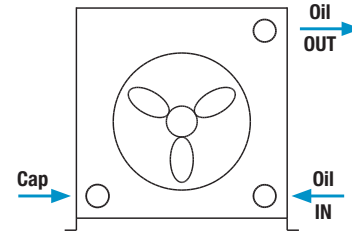

AO, AOF & AOHM Models	One Pass Flow (GPM)	AOVH & AOVHM Models	One Pass Flow (GPM)
5	2-80	5	4-160
10	3-80	10	6-160
15	4-80	15	8-160
20	5-80	20	10-160
25	6-100	25	12-200
30	7-100	30	14-200
35	8-112	35	16-220
40	9-118	40	18-230

AO, AOF & AOHM Models	Two Pass Flow (GPM)	AOVH & AOVHM Models	Two Pass Flow (GPM)
5	2-25	5	4-50
10	2-30	10	4-60
15	2-30	15	4-60
20	2-40	20	4-80
25	2-40	25	4-80
30	2-40	30	4-80
35	3-40	35	6-80
40	4-40	40	8-80

Gresen Hydraulic Motor Specifications

Model	Maximum Fan Speed (GPM)	Oil Flow Required (GMP)	Displacement (cu. in./rev)	Minimum Operating Pressure (PSI)
AOHM-5	1725	1.6	.22	300
AOHM-10	1725	1.6	.22	300
AOHM-15	1725	1.6	.22	300
AOHM-20	1725	1.6	.22	300
AOHM-25	1140	1.1	.22	400
AOHM-30	1140	1.1	.22	400
AOHM-35	1140	1.1	.22	900
AOHM-40	1140	1.1	.22	900
AOVHM-5	3450	3.3	.22	300
AOVHM-10	3450	3.3	.22	300
AOVHM-15	3450	3.3	.22	300
AOVHM-20	3450	3.3	.22	300
AOVHM-25	1725	3.4	.45	500
AOVHM-30	1725	3.4	.45	500
AOVHM-35	1725	5.2	.70	1000
AOVHM-40	1725	5.2	.70	1000

Maximum operating pressure 2000 PSI. Stated minimum operating pressure is at inlet port of motor. 1000 PSI allowable downstream back pressure.